

WEIGHTS:	HTS	LBS
RISER	6"	525
RISER	12"	1050
RISER	24"	2100
BASE	42"	3675
BASE WITH FLOOR	48"	4200

FRAME & GRATE  
GALV. STEEL  
TRAFFIC RATED

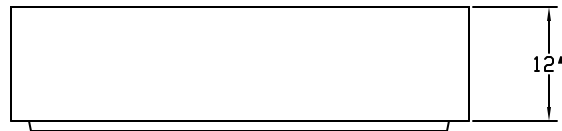

2-#4 HOOP TYP.

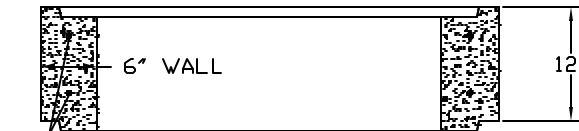
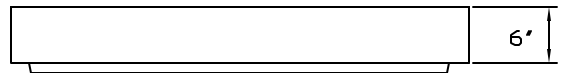
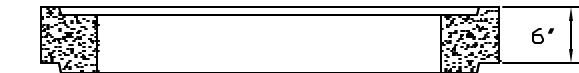
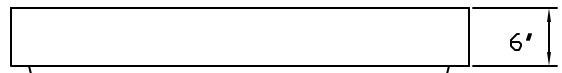
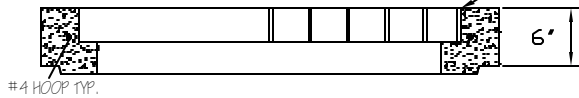
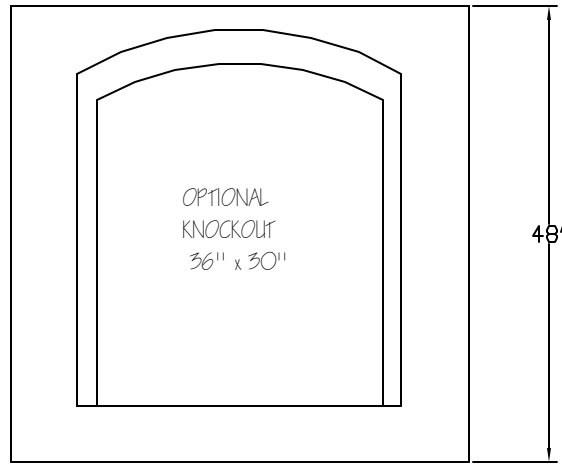
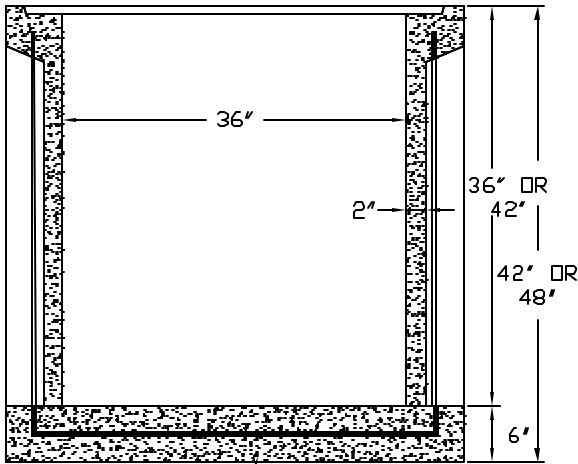

OPTIONAL  
FLOOR

REVISIONS	BY

CONTRACT NO.		
DRAWN BY KS		
CHECKED BY		
DATE 08/04/03		
P/N 3636CB		
SHEET 1 OF 1	SCALE	TITLE 36" x 36" CATCH BASIN